

**DISCONTINUED
PRODUCT**

OVERVIEW

The SM5004 Series crystal oscillator module ICs fabricated in NPC's Molybdenum-gate CMOS. They comprise low-voltage low-current consumption oscillator circuits

and output buffers. They incorporate built-in oscillation capacitance with superior frequency response to realize without any external components.

FEATURES

- Oscillation frequency up to 30MHz
- Fundamentally oscillation
- 4.5 to 5.5 V supply voltage
- Inverter amplifier feedback resistance built-in (R_f)
- Oscillation capacitances built-in (CG and CD)
- Output drive capability : 8 mA ($V_{DD}=4.5V$)
- Output frequency : f_0 , $f_0/2$, $f_0/4$, $f_0/8$
- Output duty level
CMOS, TTL, CMOS & TTL
- Input level : TTL
- 3 state function
- Chip form (CF5004××)
- 6 pin SOT (SM5004××H)

DEVICE LIST

Device	Output duty level	Output frequency	Output (standby)
SM5004A1H	CMOS	f_0	Hi-Z (Stop oscillation)
SM5004A3H	CMOS	$f_0/2$	Hi-Z (Stop oscillation)
SM5004A5H	CMOS, TTL	$f_0/4$	Hi-Z (Stop oscillation)
SM5004A7H	CMOS, TTL	$f_0/8$	Hi-Z (Stop oscillation)
SM5004B1H	TTL	f_0	Hi-Z (Stop oscillation)
SM5004B3H	TTL	$f_0/2$	Hi-Z (Stop oscillation)

Notes:

CF5004×× is Chip form.

SM5004××H is 6 pin SOT.

SM5004 Series
DISCONTINUED PRODUCT

PAD DIMENSIONS

PAD COORDINATES

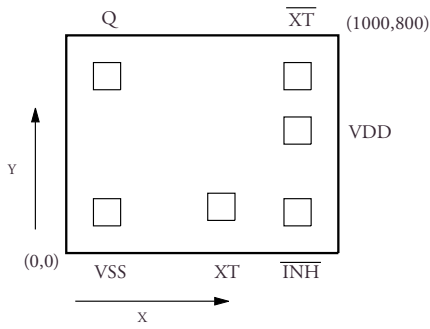

Name	Coordinates (μm)	
	X	Y
VSS	150	150
XT	570	170
$\overline{\text{INH}}$	850	150
VDD	850	450
$\overline{\text{XT}}$	850	650
Q	150	650

Chip size : 1.00x0.80 mm
Chip thickness : 250 ± 30 μm
Chip reverse side : VDD level

PIN CONFIGURATION (Top view)

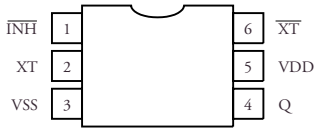

TERMINAL DESCRIPTIONS

Name	Descriptions
XT	Oscillator input pin
$\overline{\text{XT}}$	Oscillator output pin
$\overline{\text{INH}}$	Output state control input pin (with built-in pull-up resistance)
VDD	Supply voltage
VSS	Ground
Q	Output pin

DISCONTINUED
SM5004 Series
PRODUCT

PACKAGE DIMENSIONS (6 pin SOT)

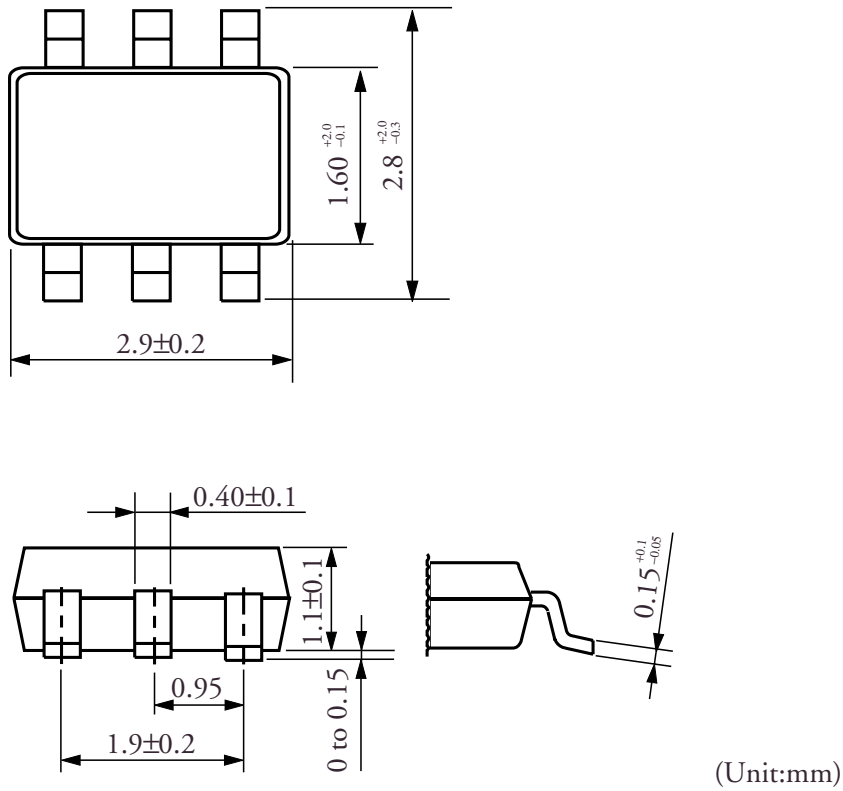

BLOCK DIAGRAM

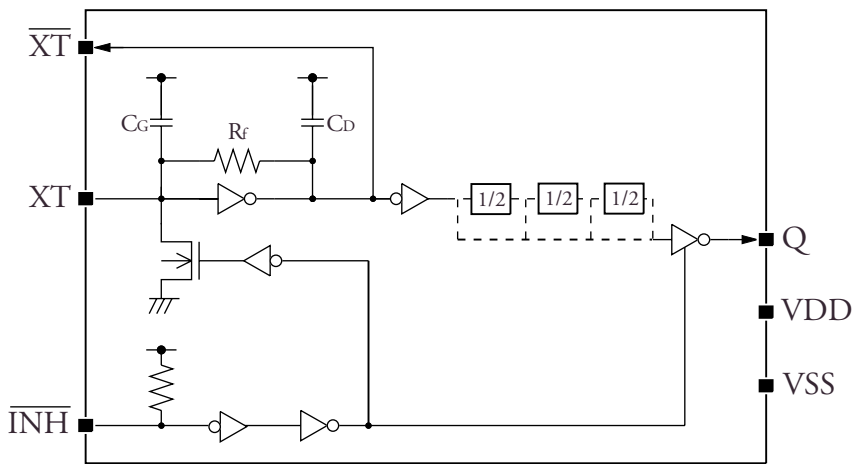

SPECIFICATIONS

Absolute Maximum Ratings

(V_{SS} = 0V unless otherwise noted)

Parameter	Symbol	Condition	Rating	Unit
Supply voltage range	V _{DD}		-0.5 to 7.0	V
Input voltage range	V _{IN}		-0.5 to V _{DD} + 0.5	V
Output voltage range	V _{OUT}		-0.5 to V _{DD} + 0.5	V
Storage temperature ranges	T _{STG}	Chip form	-65 to 150	°C
		6 pin SOT	-55 to 125	°C
Power dissipation	P _W	6 pin SOT	250	mW
Output current	I _{OUT}		13	mA
Soldering temperature	T _{SLD}	6 pin SOT	255	°C
Soldering time	t _{SLD}	6 pin SOT	10	sec

Recommended Operating Conditions

(V_{SS} = 0V unless otherwise noted)

Parameter	Symbol	Condition	Limit			Unit
			MIN	TYP	MAX	
Supply Voltage	V _{DD}		4.5		5.5	V
Input voltage	V _{IN}		V _{SS}		V _{DD}	V
Operating temperature	T _{OPR}		-20		+80	°C

Electrical Characteristics

(V_{DD} = 4.5 to 5.5V, V_{SS} = 0V, T_a = -20 to 80°C, unless otherwise noted)

Parameter	Symbol	Condition	Limit			Unit	
			MIN	TYP	MAX		
HIGH-level output voltage	V _{OH}	Q pin, test circuit 1, V _{DD} = 4.5V, I _{OH} = 8mA	3.9	4.2		V	
LOW-level output voltage	V _{OL}	Q pin, test circuit 2, V _{DD} = 4.5V, I _{OL} = 8mA		0.3	0.4	V	
Output leakage current	I _Z	Q pin, test circuit 2, INH = Low, V _{DD} = 5.5V	V _{OH} = V _{DD}		10	μA	
			V _{OL} = V _{SS}		10	μA	
HIGH-level input voltage	V _{IH}	INH pin	2.0			V	
LOW-level input voltage	V _{IL}	INH pin			0.8	V	
Current consumption	I _{DD}	INH = OPEN, test circuit 3, C _L = 15pF, f = 30MHz	SM5004A×H load circuit 1		9	14	mA
			SM5004B×H load circuit 2		9	14	mA
Pull-up resistance	R _{UP}	INH pin, test circuit 4	25	100	250	kΩ	
AC feedback resistance	R _f	test circuit 5	100	200	400	kΩ	
Internal capacitance	C _G	Design value, determined by the internal wafer pattern.	17	20	23	pF	
	C _D		17	20	23	pF	

Switching Characteristics

Duty level CMOS

($V_{DD}= 4.5$ to $5.5V$, $V_{SS} = 0V$, $T_a = -20$ to $80^{\circ}C$, unless otherwise noted)

Parameter	Symbol	Condition	Limit			Unit
			MIN	TYP	MAX	
Output rise time	t_r	Test circuit 6, load circuit 1, $C_L = 15pF$ $0.1V_{DD}$ to $0.9V_{DD}$		3.5	7	ns
Output fall time	t_f	Test circuit 6, load circuit 1, $C_L = 15pF$ $0.9V_{DD}$ to $0.1V_{DD}$		3.5	7	ns
Output duty cycle	DUTY	Test circuit 6, $T_a = 25^{\circ}C$, $V_{DD} = 5.0V$ load circuit 1, $C_L = 15pF$, $f = 30MHz$ (*1)	45		55	%
Output disable delay time	t_{PLZ}	Test circuit 6, $T_a = 25^{\circ}C$, $V_{DD} = 5.0V$ load circuit 1, $C_L = 15pF$			100	ns
Output enable delay time	t_{PZL}				100	ns

Duty level TTL

($V_{DD} = 4.5$ to $5.5V$, $V_{SS} = 0V$, $T_a = -20$ to $80^{\circ}C$, unless otherwise noted)

Parameter	Symbol	Condition	Limit			Unit
			MIN	TYP	MAX	
Output rise time	t_r	Test circuit 6, load circuit 2, $C_L = 15pF$ $0.4V_{DD}$ to $2.4V_{DD}$		2.5	7	ns
Output fall time	t_f	Test circuit 6, load circuit 2, $C_L = 15pF$ $2.4V_{DD}$ to $0.4V_{DD}$		2.5	7	ns
Output duty cycle	DUTY	Test circuit 6, $T_a = 25^{\circ}C$, $V_{DD} = 5.0V$ load circuit 2, $C_L = 15pF$, $f = 30MHz$ (*1)	45		55	%
Output disable delay time	t_{PLZ}	Test circuit 6, $T_a = 25^{\circ}C$, $V_{DD} = 5.0V$ load circuit 2, $C_L = 15pF$			100	ns
Output enable delay time	t_{PZL}				100	ns

Note:

(*1) Determined by the lot monitor.

DISCONTINUED
SM5004 Series
PRODUCT

TEST CIRCUITS

Test Circuit 1

3.5 V_{P-P}, 10MHz sine wave input signal

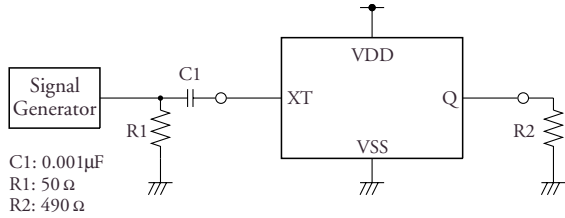

C1: 0.001μF
R1: 50 Ω
R2: 490 Ω

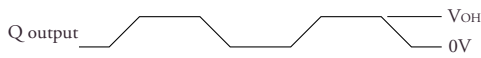

Test Circuit 2

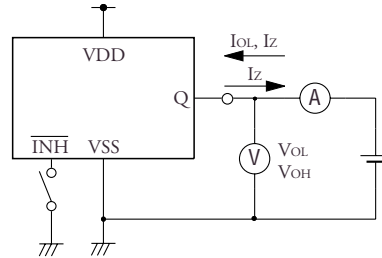

Test Circuit 3

3.5 V_{P-P}, 30MHz sine wave input signal

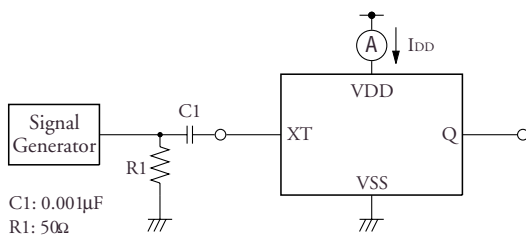

C1: 0.001μF
R1: 50Ω

Test Circuit 4

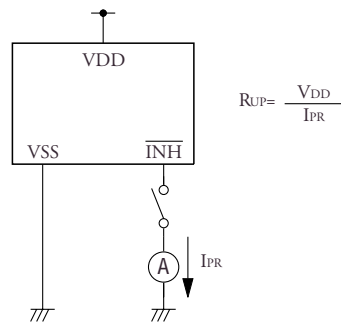

Test Circuit 5

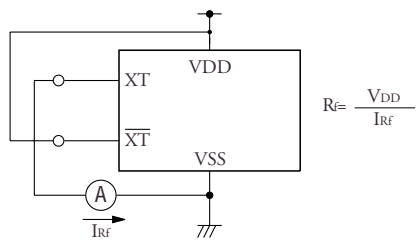

Test Circuit 6

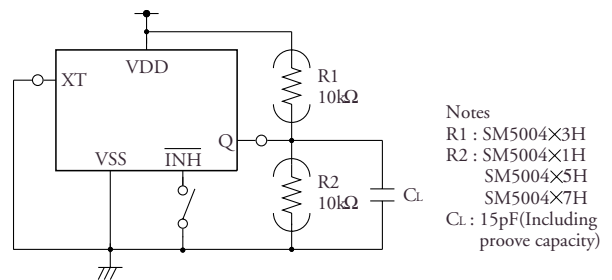

Notes
R1 : SM5004×3H
R2 : SM5004×1H
SM5004×5H
SM5004×7H
C_L : 15pF(Including proove capacity)

Load Circuit 1

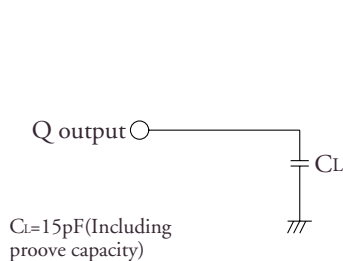

C_L=15pF(Including proove capacity)

Load Circuit 2

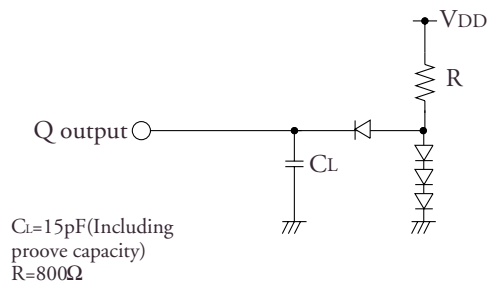

C_L=15pF(Including proove capacity)
R=800Ω

Switching Time Test Waveforms

Duty level CMOS

t_r, t_f DUTY

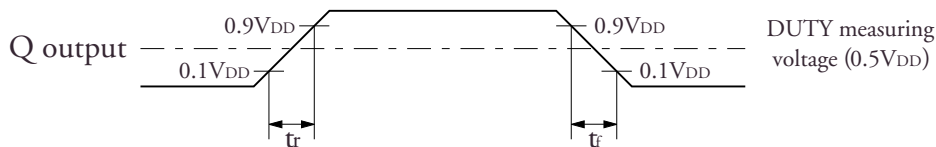

Output duty cycle time

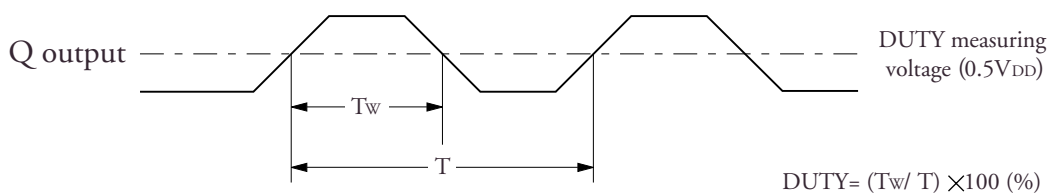

Duty level TTL

t_r, t_f DUTY

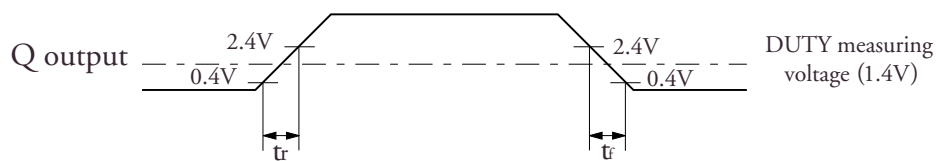

Output duty cycle time

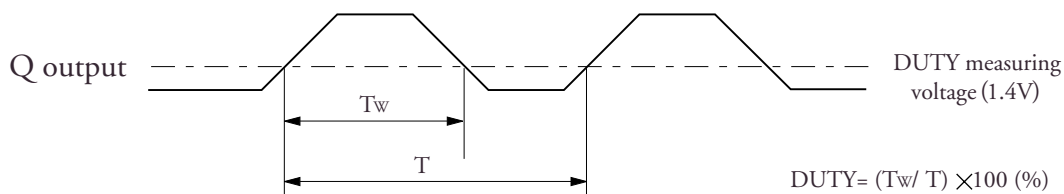

Output Disable/Enable Delay Times

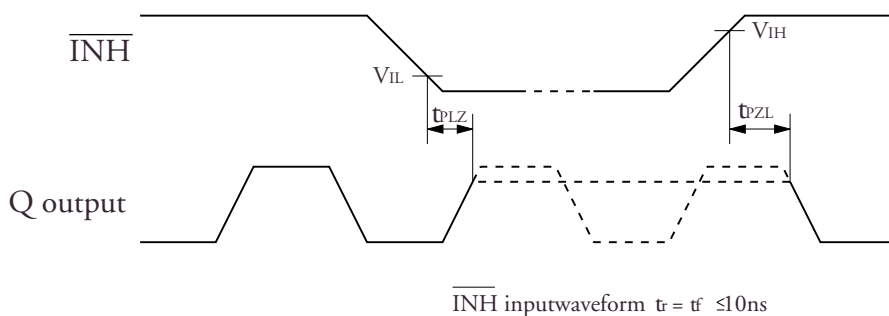

Note :

This waveform is provided by oscillating.

SM5004 Series
**DISCONTINUED
PRODUCT**

NIPPON PRECISION CIRCUITS INC. reserves the right to make changes to the products described in this data sheet in order to improve the design or performance and to supply the best possible products. Nippon Precision Circuits Inc. assumes no responsibility for the use of any circuits shown in this data sheet, conveys no license under any patent or other rights, and makes no claim that the circuits are free from patent infringement. Applications for any devices shown in this data sheet are for illustration only and Nippon Precision Circuits Inc. makes no claim or warranty that such applications will be suitable for the use specified without further testing or modification. The products described in this data sheet are not intended to use for the apparatus which influence human lives due to the failure or malfunction of the products. Customers are requested to comply with applicable laws and regulations in effect now and hereinafter, including compliance with export controls on the distribution or dissemination of the products. Customers shall not export, directly or indirectly, any products without first obtaining required licenses and approvals from appropriate government agencies.



NIPPON PRECISION CIRCUITS INC.

4-3, 2-chome Fukuzumi, Koto-ku
Tokyo, 135 -8430, JAPAN
Telephone: 03-3642-6661
Facsimile: 03-3642-6698

NC9512BE 1996 10